

Drawn Cup Needle Bearings

HN Series-**HN2016**

参数信息:

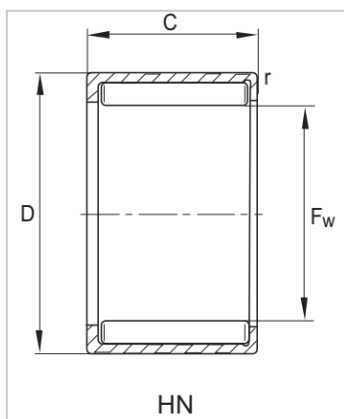

Bearing model :	HN2016
Mass (g) :	22
Dimension (mm) :	
Fw :	20
D :	26
C :	16
r min. :	0.8
Basic rated load :	
Cr :	18100
Cor :	36500
Ultimate fatigue load :	4750
Limit speed :	5200
Reference speed :	6800

: