

Drawn Cup Needle Bearings

HN Series-**HN1612**

参数信息:

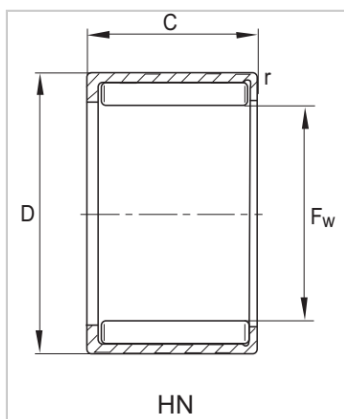

Bearing model :	HN1612
Mass (g) :	13
Dimension (mm) :	
Fw :	16
D :	22
C :	12
r min. :	0.8
Basic rated load :	
Cr :	12000
Cor :	20300
Ultimate fatigue load :	2600
Limit speed :	6300
Reference speed :	8400

: