

Drawn Cup Needle Bearings

HN Series-**HN1516**

参数信息:

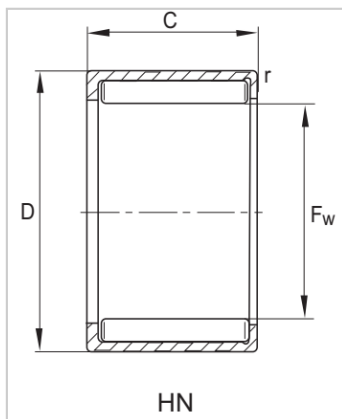

Bearing model :	HN1516
Mass (g) :	14
Dimension (mm) :	
Fw :	15
D :	21
C :	16
r min. :	0.8
Basic rated load :	
Cr :	15400
Cor :	27500
Ultimate fatigue load :	3600
Limit speed :	6700
Reference speed :	8700

: