

Drawn Cup Needle Bearings

HN Series-**HN1412**

参数信息:

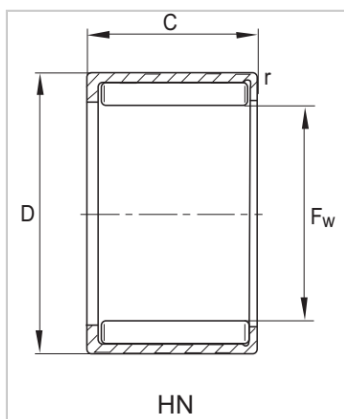

Bearing model :	HN1412
Mass (g) :	12
Dimension (mm) :	
Fw :	14
D :	20
C :	12
r min. :	0.8
Basic rated load :	
Cr :	11000
Cor :	17500
Ultimate fatigue load :	2260
Limit speed :	7100
Reference speed :	9500

: