

Drawn Cup Needle Bearings

HK、BK Series-**HK0709BK0709**

参数信息:

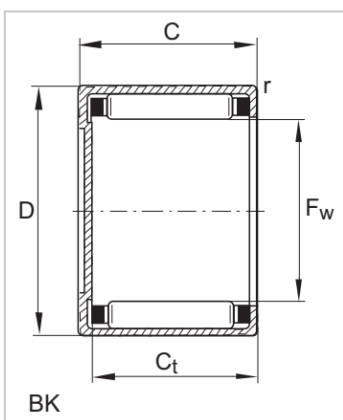
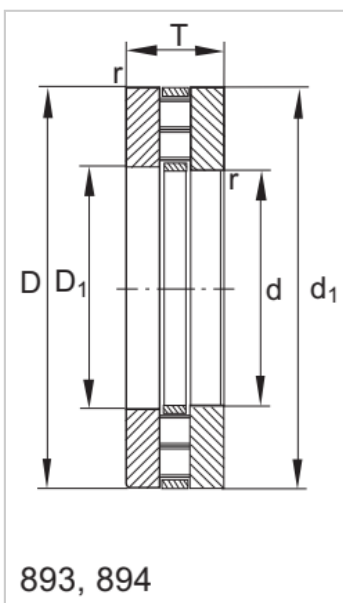

Open type :

Bearing model :	HK0709
Mass (g) :	2.6

Sealing type :

Bearing model :	BK0709
Mass (g) :	2.9

Dimension (mm) :

Fw :	7
D :	11
C-0.3 :	9
Ct min. :	7.4
r min. :	0.4

Basic rated load :

Cr :	3100
Cor :	2950

Ultimate fatigue load : 355

Limit speed :	31000
Reference speed :	24000

Matching inner ring :

LR :	-
IR :	-

: